



ASRock®



2270

KILLER SLI/BR

User Manual

Version 1.0

Published November 2016

Copyright©2016 ASRock INC. All rights reserved.

Copyright Notice:

No part of this documentation may be reproduced, transcribed, transmitted, or translated in any language, in any form or by any means, except duplication of documentation by the purchaser for backup purpose, without written consent of ASRock Inc.

Products and corporate names appearing in this documentation may or may not be registered trademarks or copyrights of their respective companies, and are used only for identification or explanation and to the owners' benefit, without intent to infringe.

Disclaimer:

Specifications and information contained in this documentation are furnished for informational use only and subject to change without notice, and should not be constructed as a commitment by ASRock. ASRock assumes no responsibility for any errors or omissions that may appear in this documentation.

With respect to the contents of this documentation, ASRock does not provide warranty of any kind, either expressed or implied, including but not limited to the implied warranties or conditions of merchantability or fitness for a particular purpose.

In no event shall ASRock, its directors, officers, employees, or agents be liable for any indirect, special, incidental, or consequential damages (including damages for loss of profits, loss of business, loss of data, interruption of business and the like), even if ASRock has been advised of the possibility of such damages arising from any defect or error in the documentation or product.



This device complies with Part 15 of the FCC Rules. Operation is subject to the following two conditions:

- (1) this device may not cause harmful interference, and
- (2) this device must accept any interference received, including interference that may cause undesired operation.

CALIFORNIA, USA ONLY

The Lithium battery adopted on this motherboard contains Perchlorate, a toxic substance controlled in Perchlorate Best Management Practices (BMP) regulations passed by the California Legislature. When you discard the Lithium battery in California, USA, please follow the related regulations in advance.

“Perchlorate Material-special handling may apply, see www.dtsc.ca.gov/hazardouswaste/perchlorate”

ASRock Website: <http://www.asrock.com>

AUSTRALIA ONLY

Our goods come with guarantees that cannot be excluded under the Australian Consumer Law. You are entitled to a replacement or refund for a major failure and compensation for any other reasonably foreseeable loss or damage caused by our goods. You are also entitled to have the goods repaired or replaced if the goods fail to be of acceptable quality and the failure does not amount to a major failure. If you require assistance please call ASRock Tel : +886-2-28965588 ext.123 (Standard International call charges apply)

The terms HDMI™ and HDMI High-Definition Multimedia Interface, and the HDMI logo are trademarks or registered trademarks of HDMI Licensing LLC in the United States and other countries.



Contents

Chapter 1 Introduction	1
1.1 Package Contents	1
1.2 Specifications	2
1.3 Motherboard Layout	7
1.4 I/O Panel	9
Chapter 2 Installation	11
2.1 Installing the CPU	12
2.2 Installing the CPU Fan and Heatsink	15
2.3 Installing Memory Modules (DIMM)	16
2.4 Expansion Slots (PCI Express Slots)	18
2.5 Jumpers Setup	19
2.6 Onboard Headers and Connectors	20
2.7 SLI™ and Quad SLI™ Operation Guide	25
2.7.1 Installing Two SLI™-Ready Graphics Cards	25
2.7.2 Driver Installation and Setup	27
2.8 CrossFireX™ and Quad CrossFireX™ Operation Guide	28
2.8.1 Installing Two CrossFireX™-Ready Graphics Cards	28
2.8.2 Driver Installation and Setup	30
2.9 M.2_SSD (NGFF) Module Installation Guide	31
Chapter 3 Software and Utilities Operation	34
3.1 Installing Drivers	34
3.2 A-Tuning	35

3.2.1	Installing A-Tuning	35
3.2.2	Using A-Tuning	35
3.3	ASRock Live Update & APP Shop	38
3.3.1	UI Overview	38
3.3.2	Apps	39
3.3.3	BIOS & Drivers	42
3.3.4	Setting	43
3.4	Enabling USB Ports for Windows® 7 Installation	44
3.5	ASRock AURA RGB LED	47
Chapter 4 UEFI SETUP UTILITY		48
4.1	Introduction	48
4.2	EZ Mode	49
4.3	Advanced Mode	50
4.3.1	UEFI Menu Bar	50
4.3.2	Navigation Keys	51
4.4	Main Screen	52
4.5	OC Tweaker Screen	53
4.6	Advanced Screen	61
4.6.1	CPU Configuration	62
4.6.2	Chipset Configuration	64
4.6.3	Storage Configuration	67
4.6.4	Intel® Thunderbolt™	68
4.6.5	Super IO Configuration	69
4.6.6	ACPI Configuration	70

4.6.7	USB Configuration	72
4.6.8	Trusted Computing	73
4.7	Tools	74
4.8	Hardware Health Event Monitoring Screen	77
4.9	Security Screen	80
4.10	Boot Screen	81
4.11	Exit Screen	83

Chapter 1 Introduction

Thank you for purchasing ASRock Z270 Killer SLI/BR motherboard, a reliable motherboard produced under ASRock's consistently stringent quality control. It delivers excellent performance with robust design conforming to ASRock's commitment to quality and endurance.

In this documentation, Chapter 1 and 2 contains the introduction of the motherboard and step-by-step installation guides. Chapter 3 contains the operation guide of the software and utilities. Chapter 4 contains the configuration guide of the BIOS setup.



Because the motherboard specifications and the BIOS software might be updated, the content of this documentation will be subject to change without notice. In case any modifications of this documentation occur, the updated version will be available on ASRock's website without further notice. If you require technical support related to this motherboard, please visit our website for specific information about the model you are using. You may find the latest VGA cards and CPU support list on ASRock's website as well. ASRock website <http://www.asrock.com>.

1.1 Package Contents

- ASRock Z270 Killer SLI/BR Motherboard (ATX Form Factor)
- ASRock Z270 Killer SLI/BR Quick Installation Guide
- ASRock Z270 Killer SLI/BR Support CD
- 1 x I/O Panel Shield
- 2 x Serial ATA (SATA) Data Cables (Optional)
- 1 x ASRock SLI_HB_Bridge_2S Card (Optional)
- 2 x Screws for M.2 Sockets (Optional)

1.2 Specifications

Platform • ATX Form Factor

CPU

- Supports 7th and 6th Generation Intel® Core™ i7/i5/i3/ Pentium®/Celeron® Processors (Socket 1151)
- Digi Power design
- 8 Power Phase design
- Supports Intel® Turbo Boost 2.0 Technology
- Supports Intel® K-Series unlocked CPUs
- Supports ASRock BCLK Full-range Overclocking

Chipset • Intel® Z270

Memory

- Dual Channel DDR4 Memory Technology
- 4 x DDR4 DIMM Slots
- Supports DDR4 3733+(OC)*/3600(OC)/3200(OC)/2933(OC) /2800(OC)/2400*/2133 non-ECC, un-buffered memory

* Please refer to Memory Support List on ASRock's website for more information. (<http://www.asrock.com/>)

** 7th Gen Intel® CPU supports DDR4 up to 2400; 6th Gen Intel® CPU supports DDR4 up to 2133.

- Supports ECC UDIMM memory modules (operate in non-ECC mode)
- Max. capacity of system memory: 64GB
- Supports Intel® Extreme Memory Profile (XMP) 2.0
- 15μ Gold Contact in DIMM Slots

Expansion Slot

- 2 x PCI Express 3.0 x16 Slots (PCIE2/PCIE4: single at x16 (PCIE2); dual at x8 (PCIE2) / x8 (PCIE4))*

* Supports NVMe SSD as boot disks

- 4 x PCI Express 3.0 x1 Slots (Flexible PCIe)
- Supports AMD Quad CrossFireX™ and CrossFireX™
- Supports NVIDIA® Quad SLI™ and SLI™
- 1 x Vertical M.2 Socket (Key E) with the bundled WiFi-802.11ac module (on the rear I/O)
- 15μ Gold Contact in VGA PCIe Slot (PCIE2)

Graphics

- Intel® HD Graphics Built-in Visuals and the VGA outputs can be supported only with processors which are GPU integrated.
- Supports Intel® HD Graphics Built-in Visuals : Intel® Quick Sync Video with AVC, MVC (S3D) and MPEG-2 Full HW Encode1, Intel® InTru™ 3D, Intel® Clear Video HD Technology, Intel® Insider™, Intel® HD Graphics
- Gen9 LP, DX11.3, DX12
- HWAEncode/Decode: VP8, HEVC 8b, VP9, HEVC 10b (For 7th Gen Intel® CPU)
- HWA Encode/Decode: VP8 , HEVC 8b; GPU/SWEncode/Decode: VP9, HEVC 10b (For 6th Gen Intel® CPU)
- Max. shared memory 1024MB

* The size of maximum shared memory may vary from different operating systems.

- Dual graphics output: Support D-Sub and HDMI ports by independent display controllers
- Supports HDMI with max. resolution up to 4K x 2K (4096x2160) @ 24Hz / (3840x2160) @ 30Hz
- Supports D-Sub with max. resolution up to 1920x1200 @ 60Hz
- Supports Auto Lip Sync, Deep Color (12bpc), xvYCC and HBR (High Bit Rate Audio) with HDMI Port (Compliant HDMI monitor is required)
- Supports HDCP with HDMI Port
- Supports Full HD 1080p Blu-ray (BD) playback with HDMI Port

Audio

- 7.1 CH HD Audio with Content Protection (Realtek ALC892 Audio Codec)
- Premium Blu-ray Audio support
- Supports Surge Protection (ASRock Full Spike Protection)
- Nichicon Fine Gold Series Audio Caps

LAN

- Gigabit LAN 10/100/1000 Mb/s
- Giga PHY Intel® I219V
- Supports Wake-On-LAN
- Supports Lightning/ESD Protection (ASRock Full Spike Protection)
- Supports Energy Efficient Ethernet 802.3az
- Supports PXE

Rear Panel I/O

- 1 x PS/2 Mouse/Keyboard Port
- 1 x D-Sub Port
- 1 x HDMI Port
- 1 x Optical SPDIF Out Port
- 5 x USB 3.0 Type-A Ports (Supports ESD Protection (ASRock Full Spike Protection))
- 1 x USB 3.0 Type-C Port (Supports ESD Protection (ASRock Full Spike Protection))
- 1 x RJ-45 LAN Port with LED (ACT/LINK LED and SPEED LED)
- HD Audio Jacks: Rear Speaker / Central / Bass / Line in / Front Speaker / Microphone

Storage

- 6 x SATA3 6.0 Gb/s Connectors, support RAID (RAID 0, RAID 1, RAID 5, RAID 10, Intel Rapid Storage Technology 15 and Intel Smart Response Technology), NCQ, AHCI and Hot Plug*
 - * If M2_1 is occupied by a SATA-type M.2 device, SATA_5 will be disabled.
 - * If M2_2 is occupied by a SATA-type M.2 device, SATA_0 will be disabled.
 - 2 x Ultra M.2 Sockets, support type 2230/2242/2260/2280 M.2 SATA3 6.0 Gb/s module and M.2 PCI Express module up to Gen3 x4 (32 Gb/s)**
- ** Supports Intel® Optane™ Technology
- ** Supports NVMe SSD as boot disks
- ** Supports ASRock U.2 Kit

Connector

- 1 x COM Port Header
- 1 x TPM Header
- 1 x Chassis Intrusion Header
- 1 x Power LED and Speaker Header
- 1 x AURA RGB LED Header
- 1 x CPU Fan Connector (4-pin)

* The CPU Fan Connector supports the CPU fan of maximum 1A (12W) fan power.

- 2 x Chassis Fan Connectors (4-pin) (Smart Fan Speed Control)
- 1 x Chassis Optional/Water Pump Fan Connector (4-pin) (Smart Fan Speed Control)

* The Chassis Optional/Water Pump Fan supports the water cooler fan of maximum 1.5A (18W) fan power.

* CHA_FAN2 can auto detect if 3-pin or 4-pin fan is in use.

- 1 x 24 pin ATX Power Connector
- 1 x 8 pin 12V Power Connector
- 1 x Front Panel Audio Connector
- 1 x Thunderbolt AIC Connector (5-pin)
- 1 x Thunderbolt AIC Connector (10-pin)

* Only one Thunderbolt AIC Card is supported.

- 3 x USB 2.0 Headers (Support 5 USB 2.0 ports) (Supports ESD Protection (ASRock Full Spike Protection))
- 1 x USB 3.0 Header (Supports 2 USB 3.0 ports) (Supports ESD Protection (ASRock Full Spike Protection))

**BIOS
Feature**

- AMI UEFI Legal BIOS with multilingual GUI support
- ACPI 6.0 Compliant wake up events
- SMBIOS 2.7 Support
- CPU, GT_CPU, DRAM, VPP, PCH 1.0V, VCCIO, VCCST, VCCSA, VCCPLL Voltage Multi-adjustment

Hardware Monitor

- CPU / Chassis / Chassis Optional/Water Pump temperature sensing
- CPU / Chassis / Chassis Optional/Water Pump Fan Tachometer
- CPU / Chassis / Chassis Optional/Water Pump Quiet Fan (Auto adjust chassis fan speed by CPU temperature)
- CPU / Chassis / Chassis Optional/Water Pump Fan multi-speed control
- CASE OPEN detection
- Voltage monitoring: +12V, +5V, +3.3V, CPU Vcore, DRAM, VPP, PCH 1.0V, VCCIO, VCCSA, VCCST

OS

- Microsoft® Windows® 10 64-bit (For 7th Gen Intel® CPU)
 - Microsoft® Windows® 10 64-bit / 8.1 64-bit / 7 32-bit / 7 64-bit (For 6th Gen Intel® CPU)
- * To install Windows® 7 OS, a modified installation disk with xHCI drivers packed into the ISO file is required. Please refer to page 44 for more detailed instructions.
- * For the updated Windows® 10 driver, please visit ASRock's website for details: <http://www.asrock.com>

Certifications

- FCC, CE, WHQL, RCM, BSMI
- ErP/EuP ready (ErP/EuP ready power supply is required)

* For detailed product information, please visit our website: <http://www.asrock.com>



Please realize that there is a certain risk involved with overclocking, including adjusting the setting in the BIOS, applying Untied Overclocking Technology, or using third-party overclocking tools. Overclocking may affect your system's stability, or even cause damage to the components and devices of your system. It should be done at your own risk and expense. We are not responsible for possible damage caused by overclocking.

1.3 Motherboard Layout

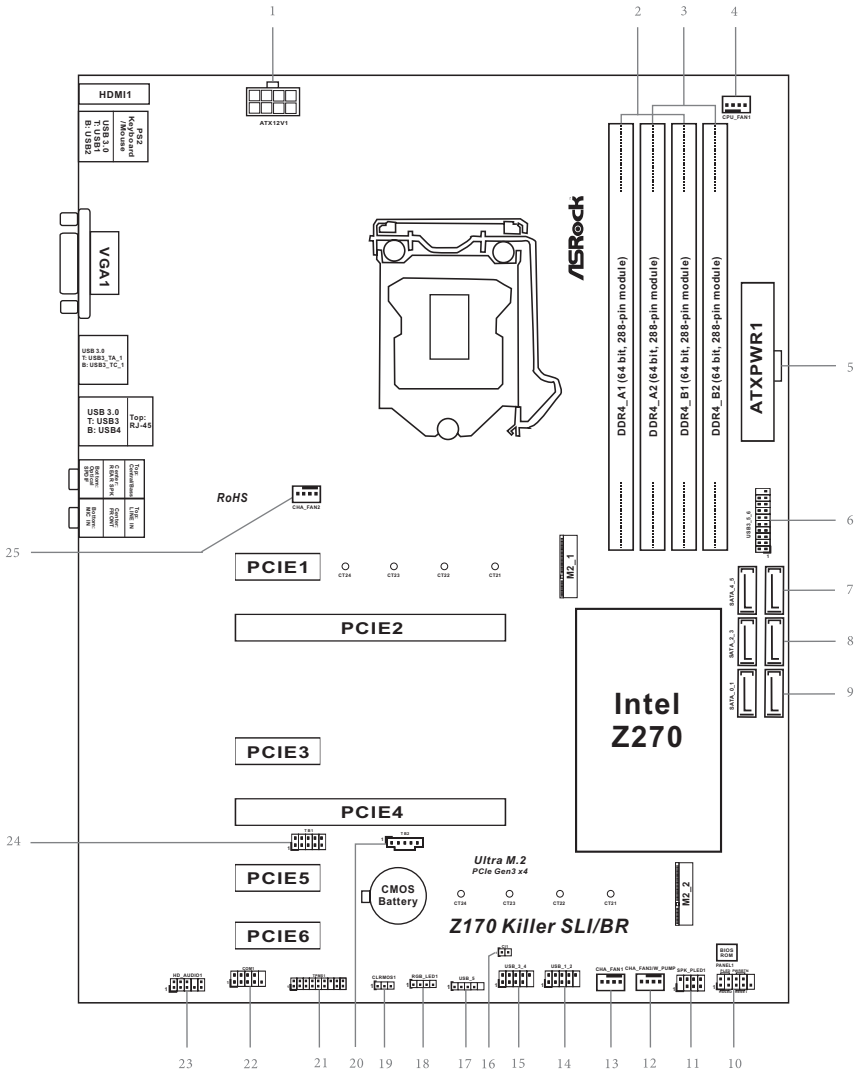

No.	Description
1	ATX 12V Power Connector (ATX12V1)
2	2 x 288-pin DDR4 DIMM Slots (DDR4_A1, DDR4_B1)
3	2 x 288-pin DDR4 DIMM Slots (DDR4_A2, DDR4_B2)
4	CPU Fan Connector (CPU_FAN1)
5	ATX Power Connector (ATXPWR1)
6	USB 3.0 Header (USB3_5_6)
7	SATA3 Connectors (SATA_4_5)
8	SATA3 Connectors (SATA_2_3)
9	SATA3 Connectors (SATA_0_1)
10	System Panel Header (PANEL1)
11	Power LED and Speaker Header (SPK_PLED1)
12	Chassis Fan / Waterpump Fan Connector (CHA_FAN3/W_PUMP)
13	Chassis Fan Connector (CHA_FAN1)
14	USB 2.0 Header (USB_1_2)
15	USB 2.0 Header (USB_3_4)
16	Chassis Intrusion Header (CI1)
17	USB 2.0 Header (USB_5)
18	AURA RGB LED Header (RGB_LED)
19	Clear CMOS Jumper (CLRMOS1)
20	Thunderbolt AIC Connector (TB2)
21	TPM Header (TPMS1)
22	COM Port Header (COM1)
23	Front Panel Audio Header (HD_AUDIO1)
24	Thunderbolt AIC Connector (TB1)
25	Chassis Fan Connector (CHA_FAN2)

1.4 I/O Panel

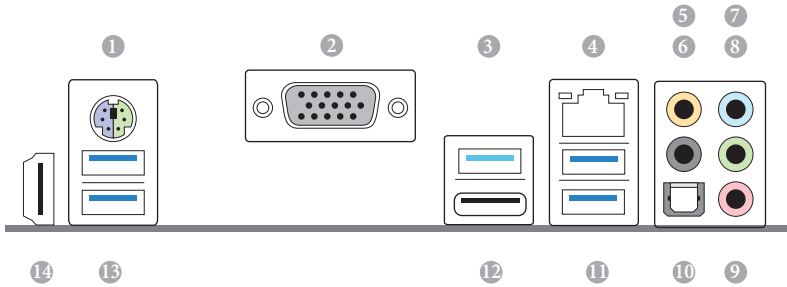

No.	Description	No.	Description
1	PS/2 Mouse/Keyboard Port	8	Front Speaker (Lime)**
2	D-Sub Port	9	Microphone (Pink)
3	USB 3.0 Type-A Port (USB3_TA_1)	10	Optical SPDIF Out Port
4	LAN RJ-45 Port*	11	USB 3.0 Ports (USB3_3_4)
5	Central / Bass (Orange)	12	USB 3.0 Type-C Port (USB3_TC_1)
6	Rear Speaker (Black)	13	USB 3.0 Ports (USB3_1_2)
7	Line In (Light Blue)	14	HDMI Port

* There are two LEDs on each LAN port. Please refer to the table below for the LAN port LED indications.

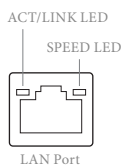

Activity / Link LED		Speed LED	
Status	Description	Status	Description
Off	No Link	Off	10Mbps connection
Blinking	Data Activity	Orange	100Mbps connection
On	Link	Green	1Gbps connection

** If you use a 2-channel speaker, please connect the speaker's plug into "Front Speaker Jack". See the table below for connection details in accordance with the type of speaker you use.

Audio Output Channels	Front Speaker (No. 8)	Rear Speaker (No. 6)	Central / Bass (No. 5)	Line In (No. 7)
2	V	--	--	--
4	V	V	--	--
6	V	V	V	--
8	V	V	V	V



To enable Multi-Streaming, you need to connect a front panel audio cable to the front panel audio header. After restarting your computer, you will find the "Mixer" tool on your system. Please select "Mixer ToolBox" , click "Enable playback multi-streaming", and click "ok". Choose "2CH", "4CH", "6CH", or "8CH" and then you are allowed to select "Realtek HDA Primary output" to use the Rear Speaker, Central/Bass, and Front Speaker, or select "Realtek HDA Audio 2nd output" to use the front panel audio.

Chapter 2 Installation

This is an ATX form factor motherboard. Before you install the motherboard, study the configuration of your chassis to ensure that the motherboard fits into it.

Pre-installation Precautions

Take note of the following precautions before you install motherboard components or change any motherboard settings.

- Make sure to unplug the power cord before installing or removing the motherboard components. Failure to do so may cause physical injuries and damages to motherboard components.
- In order to avoid damage from static electricity to the motherboard's components, NEVER place your motherboard directly on a carpet. Also remember to use a grounded wrist strap or touch a safety grounded object before you handle the components.
- Hold components by the edges and do not touch the ICs.
- Whenever you uninstall any components, place them on a grounded anti-static pad or in the bag that comes with the components.
- When placing screws to secure the motherboard to the chassis, please do not over-tighten the screws! Doing so may damage the motherboard.

2.1 Installing the CPU



1. Before you insert the 1151-Pin CPU into the socket, please check if the **PnP cap** is on the socket, if the CPU surface is unclean, or if there are any **bent pins** in the socket. Do not force to insert the CPU into the socket if above situation is found. Otherwise, the CPU will be seriously damaged.
2. Unplug all power cables before installing the CPU.

1

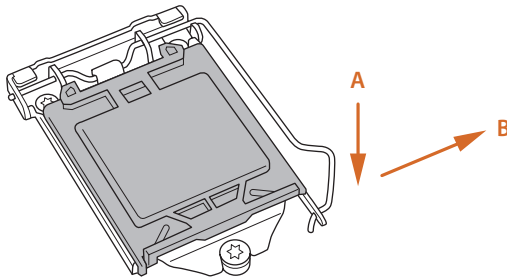

2

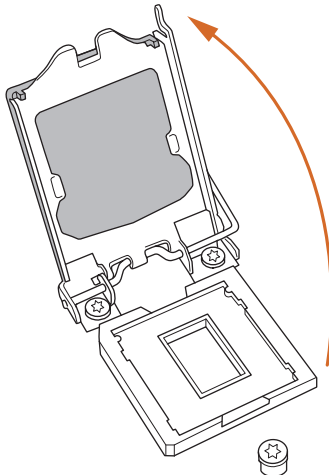

3

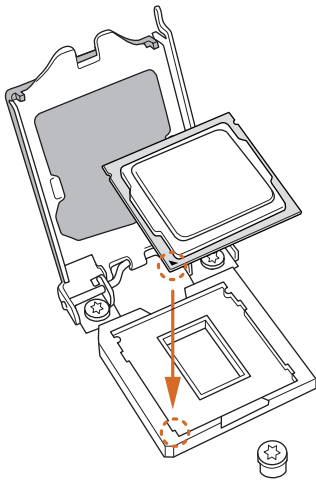

4

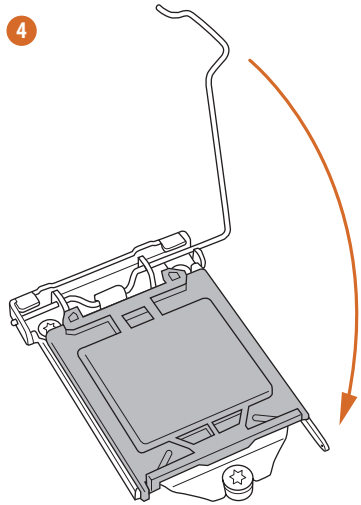

5

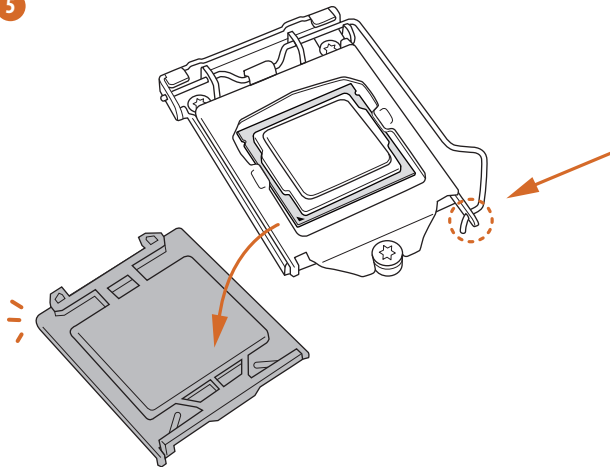



Please save and replace the cover if the processor is removed. The cover must be placed if you wish to return the motherboard for after service.

2.2 Installing the CPU Fan and Heatsink

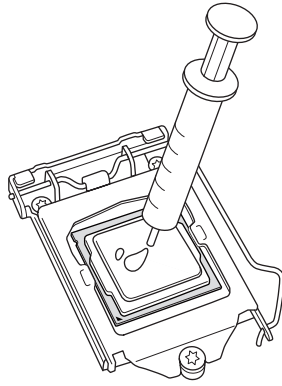
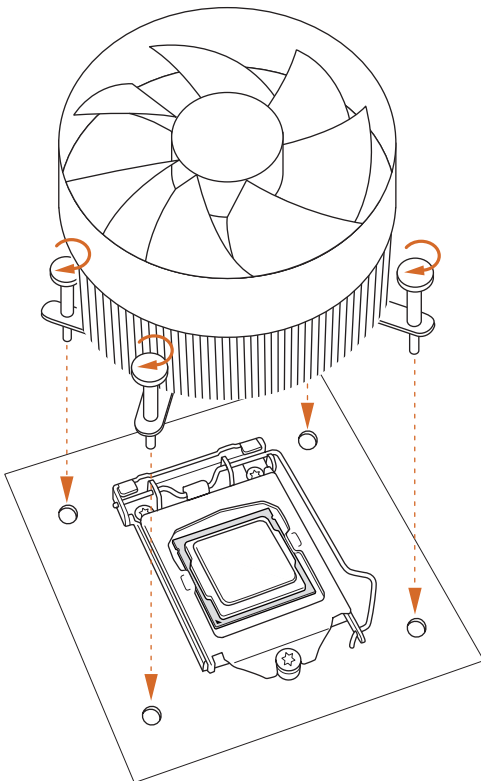
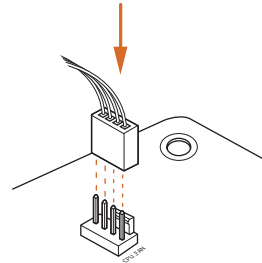
**1****2**

2.3 Installing Memory Modules (DIMM)

This motherboard provides four 288-pin DDR4 (Double Data Rate 4) DIMM slots, and supports Dual Channel Memory Technology.



1. For dual channel configuration, you always need to install identical (the same brand, speed, size and chip-type) DDR4 DIMM pairs.
2. It is unable to activate Dual Channel Memory Technology with only one or three memory module installed.
3. It is not allowed to install a DDR, DDR2 or DDR3 memory module into a DDR4 slot; otherwise, this motherboard and DIMM may be damaged.

Dual Channel Memory Configuration

Priority	DDR4_A1	DDR4_A2	DDR4_B1	DDR4_B2
1		Populated		Populated
2	Populated		Populated	
3	Populated	Populated	Populated	Populated



The DIMM only fits in one correct orientation. It will cause permanent damage to the motherboard and the DIMM if you force the DIMM into the slot at incorrect orientation.

1

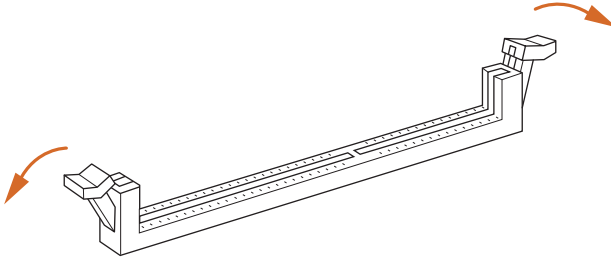

2

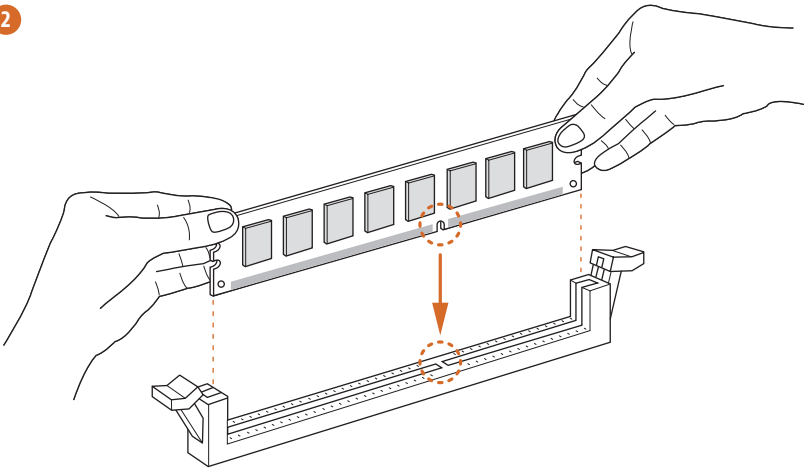

3

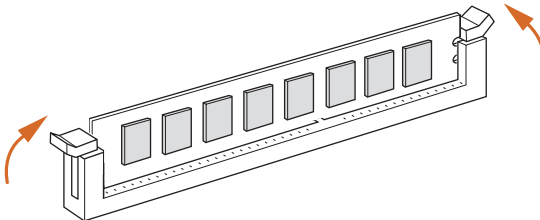

2.4 Expansion Slots (PCI Express Slots)

There are 6 PCI Express slots on the motherboard.



Before installing an expansion card, please make sure that the power supply is switched off or the power cord is unplugged. Please read the documentation of the expansion card and make necessary hardware settings for the card before you start the installation.

PCIe slots:

PCIE1 (PCIe 3.0 x1 slot) is used for PCI Express x1 lane width cards.

PCIE2 (PCIe 3.0 x16 slot) is used for PCI Express x16 lane width graphics cards.

PCIE3 (PCIe 3.0 x1 slot) is used for PCI Express x1 lane width cards.

PCIE4 (PCIe 3.0 x16 slot) is used for PCI Express x8 lane width graphics cards.

PCIE5 (PCIe 3.0 x1 slot) is used for PCI Express x1 lane width cards.

PCIE6 (PCIe 3.0 x1 slot) is used for PCI Express x1 lane width cards.

PCIe Slot Configurations

	PCIE2	PCIE4
Single Graphics Card	x16	N/A
Two Graphics Cards in CrossFireX™ or SLI™ Mode	x8	x8



For a better thermal environment, please connect a chassis fan to the motherboard's chassis fan connector (CHA_FAN1, CHA_FAN2 or CHA_FAN3) when using multiple graphics cards.

2.5 Jumpers Setup

The illustration shows how jumpers are setup. When the jumper cap is placed on the pins, the jumper is “Short”. If no jumper cap is placed on the pins, the jumper is “Open”. The illustration shows a 3-pin jumper whose pin1 and pin2 are “Short” when a jumper cap is placed on these 2 pins.

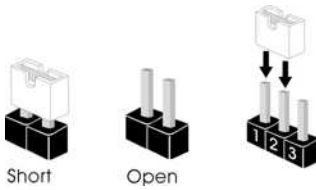

Clear CMOS Jumper
(CLRMOS1)
(see p.7, No. 19)

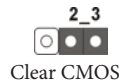

CLRMOS1 allows you to clear the data in CMOS. To clear and reset the system parameters to default setup, please turn off the computer and unplug the power cord from the power supply. After waiting for 15 seconds, use a jumper cap to short pin2 and pin3 on CLRMOS1 for 5 seconds. However, please do not clear the CMOS right after you update the BIOS. If you need to clear the CMOS when you just finish updating the BIOS, you must boot up the system first, and then shut it down before you do the clear-CMOS action. Please be noted that the password, date, time, and user default profile will be cleared only if the CMOS battery is removed.

2.6 Onboard Headers and Connectors



Onboard headers and connectors are NOT jumpers. Do NOT place jumper caps over these headers and connectors. Placing jumper caps over the headers and connectors will cause permanent damage to the motherboard.

System Panel Header
(9-pin PANEL1)
(see p.7, No. 10)

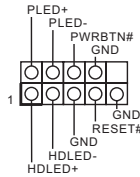

Connect the power switch, reset switch and system status indicator on the chassis to this header according to the pin assignments below. Note the positive and negative pins before connecting the cables.



PWRBTN (Power Switch):

Connect to the power switch on the chassis front panel. You may configure the way to turn off your system using the power switch.

RESET (Reset Switch):

Connect to the reset switch on the chassis front panel. Press the reset switch to restart the computer if the computer freezes and fails to perform a normal restart.

PLED (System Power LED):

Connect to the power status indicator on the chassis front panel. The LED is on when the system is operating. The LED keeps blinking when the system is in S1/S3 sleep state. The LED is off when the system is in S4 sleep state or powered off (S5).

HDLED (Hard Drive Activity LED):

Connect to the hard drive activity LED on the chassis front panel. The LED is on when the hard drive is reading or writing data.

The front panel design may differ by chassis. A front panel module mainly consists of power switch, reset switch, power LED, hard drive activity LED, speaker and etc. When connecting your chassis front panel module to this header, make sure the wire assignments and the pin assignments are matched correctly.

Power LED and Speaker Header
 (7-pin SPK_PLED1)
 (see p.7, No. 11)

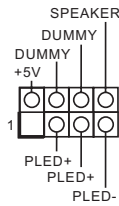

Please connect the chassis power LED and the chassis speaker to this header.

Serial ATA3 Connectors
 (SATA_0_1:
 see p.7, No. 9)
 (SATA_2_3:
 see p.7, No. 8)
 (SATA_4_5:
 see p.7, No. 7)

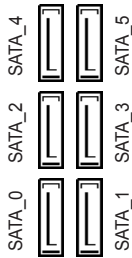

These six SATA3 connectors support SATA data cables for internal storage devices with up to 6.0 Gb/s data transfer rate.
 * If M2_1 is occupied by a SATA-type M.2 device, SATA_5 will be disabled.
 * If M2_2 is occupied by a SATA-type M.2 device, SATA_0 will be disabled.

USB 2.0 Headers
 (9-pin USB_1_2
 (see p.7, No. 14)
 (9-pin USB_3_4)
 (see p.7, No. 15)

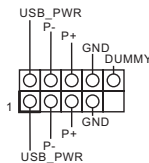

There are three headers on this motherboard. Each USB 2.0 header can support two ports.

(9-pin USB_5)
 (see p.7, No. 17)

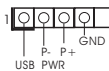

USB 3.0 Header
 (19-pin USB3_5_6)
 (see p.7, No. 6)

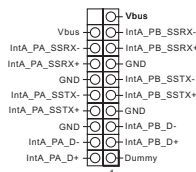

There is one header on this motherboard. Each USB 3.0 header can support two ports.

Front Panel Audio Header
(9-pin HD_AUDIO1)
(see p.7, No. 23)

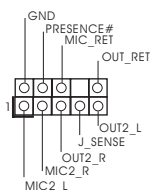

This header is for connecting audio devices to the front audio panel.



1. High Definition Audio supports Jack Sensing, but the panel wire on the chassis must support HDA to function correctly. Please follow the instructions in our manual and chassis manual to install your system.
2. If you use an AC'97 audio panel, please install it to the front panel audio header by the steps below:
 - A. Connect Mic_IN (MIC) to MIC2_L.
 - B. Connect Audio_R (RIN) to OUT2_R and Audio_L (LIN) to OUT2_L.
 - C. Connect Ground (GND) to Ground (GND).
 - D. MIC_RET and OUT_RET are for the HD audio panel only. You don't need to connect them for the AC'97 audio panel.
 - E. To activate the front mic, go to the "FrontMic" Tab in the Realtek Control panel and adjust "Recording Volume".

Chassis Fan Connectors
(4-pin CHA_FAN1)
(see p.7, No. 13)
(4-pin CHA_FAN2)
(see p.7, No. 25)

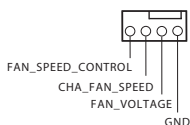

Please connect fan cables to the fan connectors and match the black wire to the ground pin.

Chassis Optional/Water Pump Fan Connector
(4-pin CHA_FAN3/W_PUMP)
(see p.7, No. 12)

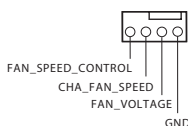

This motherboard provides two 4-Pin water cooling chassis fan connectors. If you plan to connect a 3-Pin chassis water cooler fan, please connect it to Pin 1-3.

CPU Fan Connector
(4-pin CPU_FAN1)
(see p.7, No. 4)

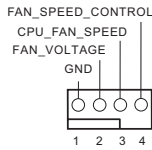

This motherboard provides a 4-Pin CPU fan (Quiet Fan) connector. If you plan to connect a 3-Pin CPU fan, please connect it to Pin 1-3.

ATX Power Connector
(24-pin ATXPWR1)
(see p.7, No. 5)

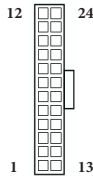

This motherboard provides a 24-pin ATX power connector. To use a 20-pin ATX power supply, please plug it along Pin 1 and Pin 13.

ATX 12V Power Connector
(8-pin ATX12V1)
(see p.7, No. 1)

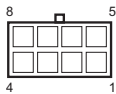

This motherboard provides an 8-pin ATX 12V power connector. To use a 4-pin ATX power supply, please plug it along Pin 1 and Pin 5.

Thunderbolt AIC Connectors
(10-pin TB1)
(see p.7, No. 24)

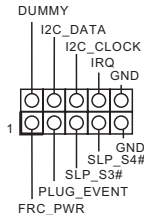

Please connect a Thunderbolt™ add-in card (AIC) to the Thunderbolt AIC connector via the GPIO cable.

* Please install the Thunderbolt™ AIC card to PCIE4 (default slot).

* Only one Thunderbolt AIC Card is supported on this motherboard.

(5-pin TB2)
(see p.7, No. 20)



Serial Port Header
(9-pin COM1)
(see p.7, No. 22)

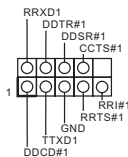

This COM1 header supports a serial port module.

Chassis Intrusion Header
(2-pin C11)
(see p.7, No. 16)



This motherboard supports CASE OPEN detection feature that detects if the chassis cover has been removed. This feature requires a chassis with chassis intrusion detection design.

TPM Header
(17-pin TPMS1)
(see p.7, No. 21)



This connector supports Trusted Platform Module (TPM) system, which can securely store keys, digital certificates, passwords, and data. A TPM system also helps enhance network security, protects digital identities, and ensures platform integrity.

AURA RGB LED Header
(4-pin RGB_LED)
(see p.7, No. 18)



AURA RGB LED header is used to connect RGB LED extension cable which allows users to choose from various LED lighting effects.
Caution: Never install the RGB LED cable in the wrong orientation; otherwise, the cable may be damaged.

2.7 SLI™ and Quad SLI™ Operation Guide

This motherboard supports NVIDIA® SLI™ and Quad SLI™ (Scalable Link Interface) technology that allows you to install up to two identical PCI Express x16 graphics cards.



Requirements

1. You should only use identical SLI™-ready graphics cards that are NVIDIA® certified.
2. Make sure that your graphics card driver supports NVIDIA® SLI™ technology. Download the drivers from the NVIDIA® website: www.nvidia.com
3. Make sure that your power supply unit (PSU) can provide at least the minimum power your system requires. It is recommended to use a NVIDIA® certified PSU. Please refer to the NVIDIA® website for details.

2.7.1 Installing Two SLI™-Ready Graphics Cards

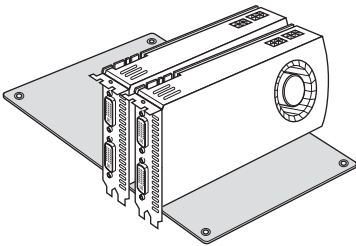

Step 1

Insert one graphics card into PCIE2 slot and the other graphics card to PCIE4 slot. Make sure that the cards are properly seated on the slots.

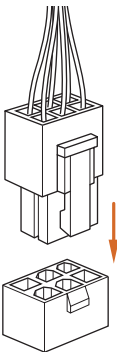

Step 2

If required, connect the auxiliary power source to the PCI Express graphics cards.

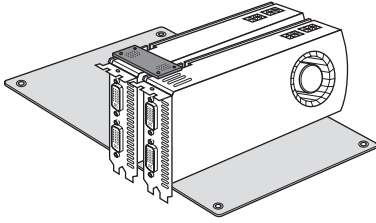

Step 3

Align and insert the ASRock SLI_HB_Bridge_2S Card to the goldfingers on each graphics card. Make sure the ASRock SLI_HB_Bridge_2S Card is firmly in place.



ASRock SLI_HB_Bridge_2S Card

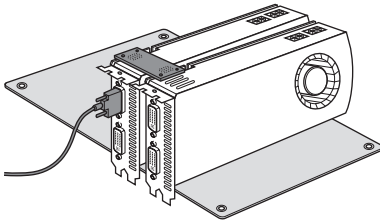

Step 4

Connect a VGA cable or a DVI cable to the monitor connector or the DVI connector of the graphics card that is inserted to PCIE2 slot.

2.7.2 Driver Installation and Setup

Install the graphics card drivers to your system. After that, you can enable the Multi-Graphics Processing Unit (GPU) in the NVIDIA® nView system tray utility. Please follow the below procedures to enable the multi-GPU.

For SLI™ and Quad SLI™ mode



Step 1

Double-click the **NVIDIA Control Panel** icon in the Windows® system tray.



Step 2

In the left pane, click **Set SLI and PhysX configuration**. Then select **Maximize 3D performance** and click **Apply**.

Step 3

Reboot your system.

Step 4

You can freely enjoy the benefits of SLI™ or Quad SLI™.

2.8 CrossFireX™ and Quad CrossFireX™ Operation Guide

This motherboard supports CrossFireX™ and Quad CrossFireX™ that allows you to install up to three identical PCI Express x16 graphics cards.



1. You should only use identical CrossFireX™-ready graphics cards that are AMD certified.
2. Make sure that your graphics card driver supports AMD CrossFireX™ technology. Download the drivers from the AMD's website: www.amd.com
3. Make sure that your power supply unit (PSU) can provide at least the minimum power your system requires. It is recommended to use a AMD certified PSU. Please refer to the AMD's website for details.
4. If you pair a 12-pipe CrossFireX™ Edition card with a 16-pipe card, both cards will operate as 12-pipe cards while in CrossFireX™ mode.
5. Different CrossFireX™ cards may require different methods to enable CrossFireX™. Please refer to AMD graphics card manuals for detailed installation guide.

2.8.1 Installing Two CrossFireX™-Ready Graphics Cards

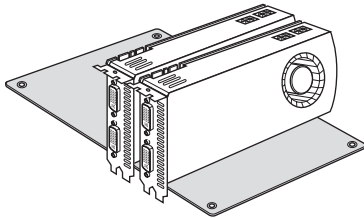

Step 1

Insert one graphics card into PCIE2 slot and the other graphics card to PCIE4 slot. Make sure that the cards are properly seated on the slots.



CrossFire Bridge

Step 2

Connect two graphics cards by installing a CrossFire Bridge on the CrossFire Bridge Interconnects on the top of the graphics cards. (The CrossFire Bridge is provided with the graphics card you purchase, not bundled with this motherboard. Please refer to your graphics card vendor for details.)

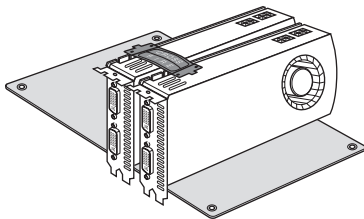

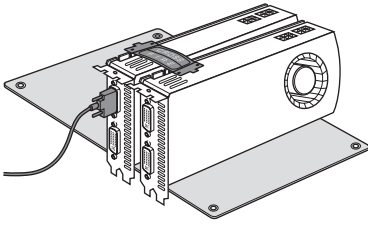
**Step 3**

Connect a VGA cable or a DVI cable to the monitor connector or the DVI connector of the graphics card that is inserted to PCIE2 slot.

2.8.2 Driver Installation and Setup

Step 1

Power on your computer and boot into OS.

Step 2

Remove the AMD drivers if you have any VGA drivers installed in your system.



The Catalyst Uninstaller is an optional download. We recommend using this utility to uninstall any previously installed Catalyst drivers prior to installation. Please check AMD's website for AMD driver updates.

Step 3

Install the required drivers and CATALYST Control Center then restart your computer. Please check AMD's website for details.



AMD Catalyst Control Center

Step 4

Double-click the **AMD Catalyst Control Center** icon in the Windows' system tray.



Step 5

In the left pane, click **Performance** and then **AMD CrossFireX™**. Then select **Enable AMD CrossFireX** and click **Apply**. Select the GPU number according to your graphics card and click **Apply**.

2.9 M.2_SSD (NGFF) Module Installation Guide

The M.2, also known as the Next Generation Form Factor (NGFF), is a small size and versatile card edge connector that aims to replace mPCIe and mSATA. The Ultra M.2 Socket (M2_1 and M2_2) supports SATA3 6.0 Gb/s module and M.2 PCI Express module up to Gen3 x4 (32 Gb/s).

* If M2_1 is occupied by a SATA-type M.2 device, SATA_5 will be disabled.

* If M2_2 is occupied by a SATA-type M.2 device, SATA_0 will be disabled.

Installing the M.2_SSD (NGFF) Module

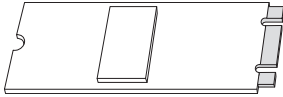

Step 1

Prepare a M.2_SSD (NGFF) module and the screw.

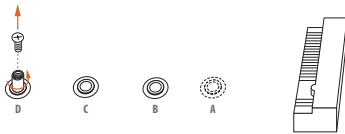

Step 2

Depending on the PCB type and length of your M.2_SSD (NGFF) module, find the corresponding nut location to be used.

No.	1	2	3	4
Nut Location	A	B	C	D
PCB Length	3cm	4.2cm	6cm	8cm
Module Type	Type2230	Type 2242	Type2260	Type 2280

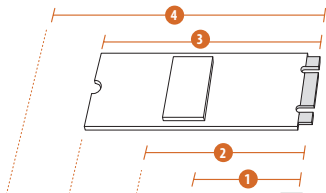

Step 3

Move the standoff based on the module type and length. The standoff is placed at the nut location D by default. Skip Step 3 and 4 and go straight to Step 5 if you are going to use the default nut. Otherwise, release the standoff by hand.



Step 4

Peel off the yellow protective film on the nut to be used. Hand tighten the standoff into the desired nut location on the motherboard.

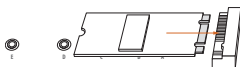

Step 5

Align and gently insert the M.2 (NGFF) SSD module into the M.2 slot. Please be aware that the M.2 (NGFF) SSD module only fits in one orientation.

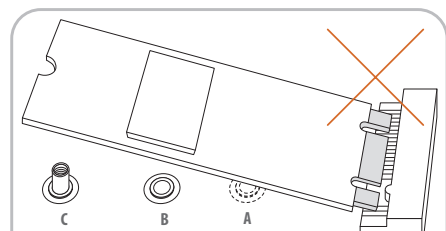

Step 6

Tighten the screw with a screwdriver to secure the module into place. Please do not overtighten the screw as this might damage the module.

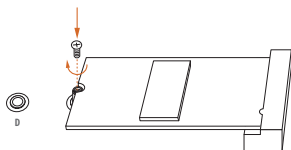

M.2_SSD (NGFF) Module Support List

Vendor	Size	Interface	Length	P/N
ADATA	128GB	SATA3	2280	AXNS381E-128GM-B
ADATA	256GB	SATA3	2280	AXNS381E-256GM-B
ADATA	32GB	SATA3	2230	AXNS330E-32GM-B
Crucial	120GB	SATA3	2280	CT120M500SSD4
Crucial	240GB	SATA3	2280	CT240M500SSD4
Intel	80GB	SATA3	2280	Intel SSDSCKGW080A401/80G
Intel	256GB	PCIe3 x4	2280	SSDPEKKF256G7
Intel	512GB	PCIe3 x4	2280	SSDPEKKF512G7
Kingston	120GB	SATA3	2280	SM2280S3
Kingston	480GB	PCIe2 x4	2280	SH2280S3/480G
OCZ	512GB	PCIe3 x4	2280	RVD400 -M2280-512G (NVME)
Plextor	128GB	PCIe3 x4	2280	PX-128M8PeG
Plextor	1TB	PCIe3 x4	2280	PX-1TM8PeG
Plextor	256GB	PCIe3 x4	2280	PX-256M8PeG
Plextor	256GB	PCIe	2280	PX-G256M6e
Plextor	512GB	PCIe3 x4	2280	PX-512M8PeG
Plextor	512GB	PCIe	2280	PX-G512M6e
Samsung	256GB	PCIe3 x4	2280	SM951 (MZHPV256HDGL)
Samsung	256GB	PCIe3 x4	2280	SM951 (NVME)
Samsung	512GB	PCIe3 x4	2280	SM951 (MZHPV512HDGL)
Samsung	512GB	PCIe3 x4	2280	SM951 (NVME)
Samsung	512GB	PCIe x4	2280	XP941-512G (MZHPU512HCGL)
SanDisk	128GB	PCIe	2260	SD6PP4M-128G
SanDisk	256GB	PCIe	2260	SD6PP4M-256G
Team	128GB	SATA3	2242	TM4PS4128GMC105
Team	128GB	SATA3	2280	TM8PS4128GMC105
Team	256GB	SATA3	2280	TM8PS4256GMC105
Team	256GB	SATA3	2242	TM4PS4256GMC105
Transcend	256GB	SATA3	2242	TS256GMTS400
Transcend	512GB	SATA3	2260	TS512GMTS600
Transcend	512GB	SATA3	2280	TS512GMTS800
V-Color	120GB	SATA3	2280	VLM100-120G-2280B-RD
V-Color	240GB	SATA3	2280	VLM100-240G-2280B-RD
V-Color	240GB	SATA3	2280	VSM100-240G-2280

For the latest updates of M.2_SSD (NFGG) module support list, please visit our website for details: <http://www.asrock.com>

Chapter 3 Software and Utilities Operation

3.1 Installing Drivers

The Support CD that comes with the motherboard contains necessary drivers and useful utilities that enhance the motherboard's features.

Running The Support CD

To begin using the support CD, insert the CD into your CD-ROM drive. The CD automatically displays the Main Menu if "AUTORUN" is enabled in your computer. If the Main Menu does not appear automatically, locate and double click on the file "ASRSETUP.EXE" in the Support CD to display the menu.

Drivers Menu

The drivers compatible to your system will be auto-detected and listed on the support CD driver page. Please click **Install All** or follow the order from top to bottom to install those required drivers. Therefore, the drivers you install can work properly.

Utilities Menu

The Utilities Menu shows the application software that the motherboard supports. Click on a specific item then follow the installation wizard to install it.



*To improve Windows 7 compatibility, please download and install the following hot fix provided by Microsoft.
"KB2720599": <http://support.microsoft.com/kb/2720599/en-us>*

3.2 A-Tuning

A-Tuning is ASRock's multi purpose software suite with a new interface, more new features and improved utilities.

3.2.1 Installing A-Tuning

A-Tuning can be downloaded from ASRock Live Update & APP Shop. After the installation, you will find the icon "A-Tuning" on your desktop. Double-click the "A-Tuning" icon, A-Tuning main menu will pop up.



3.2.2 Using A-Tuning

There are six sections in A-Tuning main menu: Operation Mode, OC Tweaker, System Info, FAN-Tastic Tuning and Settings.

Operation Mode

Choose an operation mode for your computer.

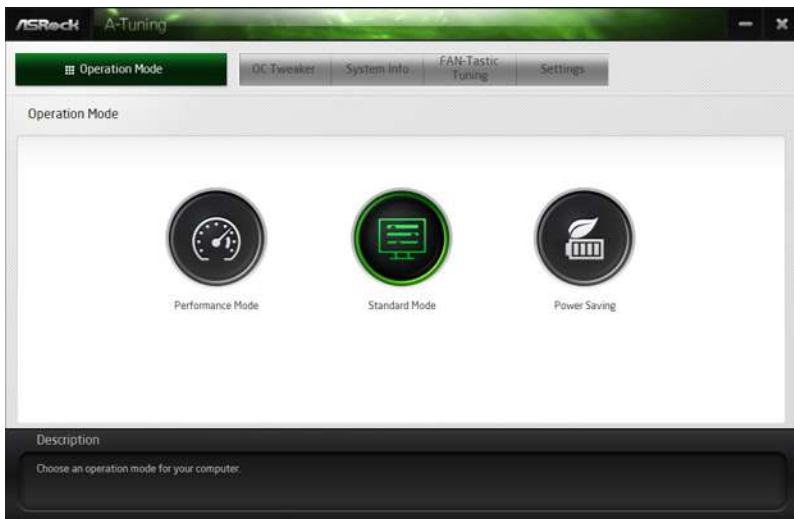

OC Tweaker

Configurations for overclocking the system.

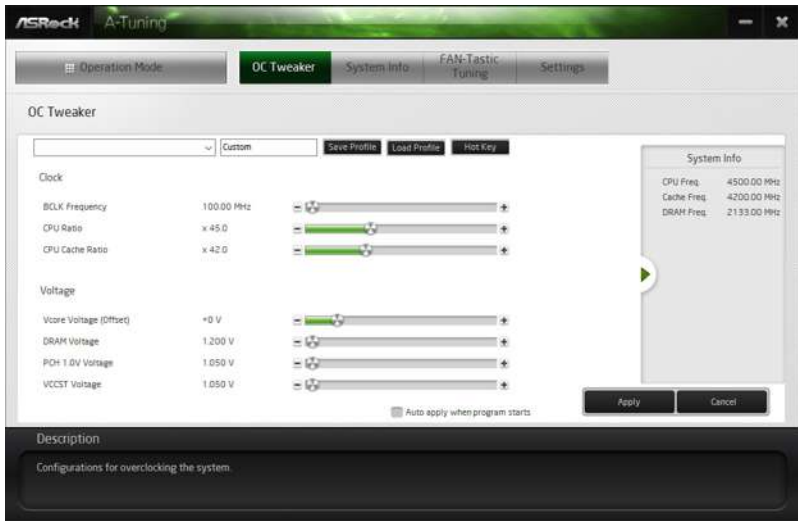

System Info

View information about the system.

*The System Browser tab may not appear for certain models.

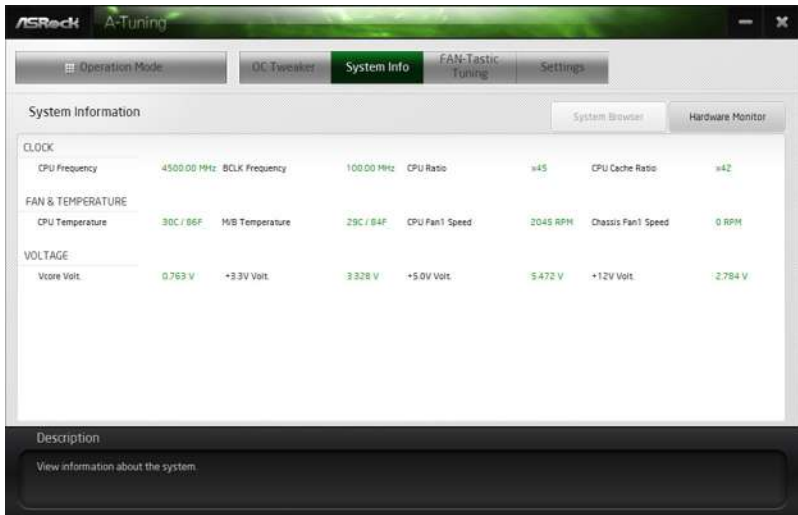

FAN-Tastic Tuning

Configure up to five different fan speeds using the graph. The fans will automatically shift to the next speed level when the assigned temperature is met.

FAN-Tastic Tuning

CPU FAN1

Start FAN Test

Fan Power	Fan Speed
100%	N/A RPM
90%	N/A RPM
80%	N/A RPM
70%	N/A RPM
60%	N/A RPM
50%	N/A RPM
40%	N/A RPM
30%	N/A RPM
20%	N/A RPM
10%	N/A RPM

Auto apply when program starts

Apply Cancel

Description

Configure different fan speeds for respective temperatures using the graph. The fans will automatically shift to the next speed level when the assigned temperature is met.

Settings

Configure ASRock A-Tuning. Click to select "Auto run at Windows Startup" if you want A-Tuning to be launched when you start up the Windows operating system.

Settings

Auto run at Windows Startup

Version: 3.0.9.8

Description

Configure ASRock A-Tuning.

3.3 ASRock Live Update & APP Shop

The ASRock Live Update & APP Shop is an online store for purchasing and downloading software applications for your ASRock computer. You can quickly and easily install various apps and support utilities. With ASRock Live Update & APP Shop, you can optimize your system and keep your motherboard up to date simply with a few clicks.

Double-click  on your desktop to access ASRock Live Update & APP Shop utility.

**You need to be connected to the Internet to download apps from the ASRock Live Update & APP Shop.*

3.3.1 UI Overview

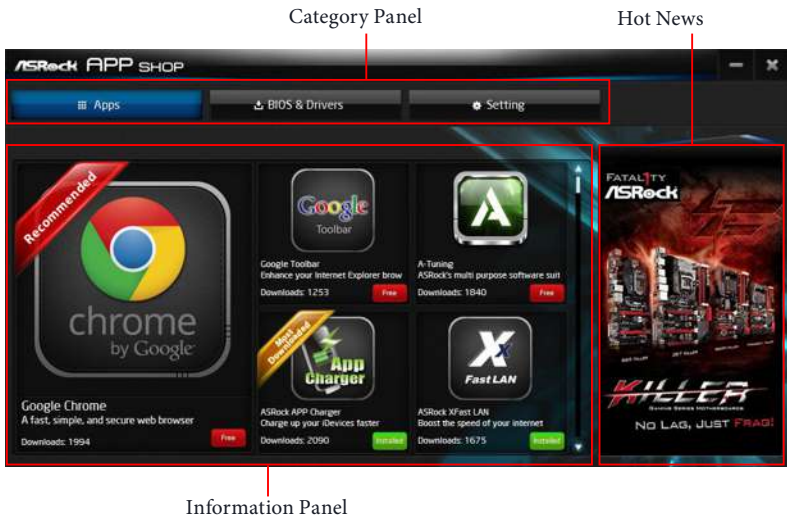

Category Panel: The category panel contains several category tabs or buttons that when selected the information panel below displays the relative information.

Information Panel: The information panel in the center displays data about the currently selected category and allows users to perform job-related tasks.

Hot News: The hot news section displays the various latest news. Click on the image to visit the website of the selected news and know more.

3.3.2 Apps

When the "Apps" tab is selected, you will see all the available apps on screen for you to download.

Installing an App

Step 1

Find the app you want to install.



The most recommended app appears on the left side of the screen. The other various apps are shown on the right. Please scroll up and down to see more apps listed.

You can check the price of the app and whether you have already installed it or not.

Free - The red icon displays the price or "Free" if the app is free of charge.

Installed - The green "Installed" icon means the app is installed on your computer.

Step 2

Click on the app icon to see more details about the selected app.

Step 3

If you want to install the app, click on the red icon  to start downloading.



Step 4

When installation completes, you can find the green "Installed" icon appears on the upper right corner.



To uninstall it, simply click on the trash can icon .

*The trash icon may not appear for certain apps.

Upgrading an App

You can only upgrade the apps you have already installed. When there is an available new version for your app, you will find the mark of "New Version"  appears below the installed app icon.



Step 1

Click on the app icon to see more details.

Step 2

Click on the yellow icon  to start upgrading.

3.3.3 BIOS & Drivers

Installing BIOS or Drivers

When the "BIOS & Drivers" tab is selected, you will see a list of recommended or critical updates for the BIOS or drivers. Please update them all soon.

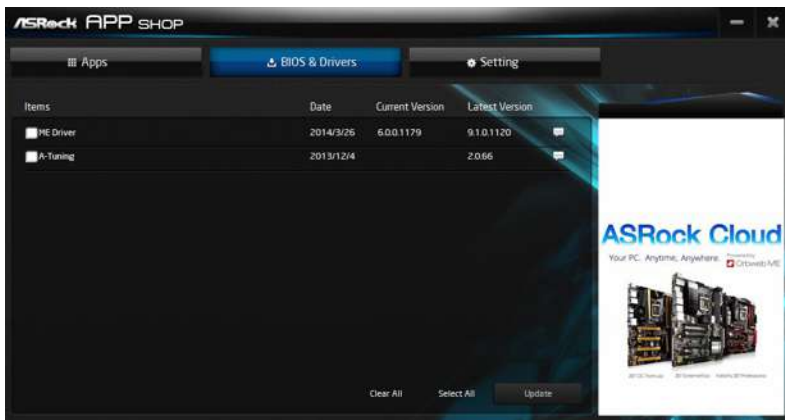

Step 1

Please check the item information before update. Click on  to see more details.

Step 2

Click to select one or more items you want to update.

Step 3

Click Update to start the update process.

3.3.4 Setting

In the "Setting" page, you can change the language, select the server location, and determine if you want to automatically run the ASRock Live Update & APP Shop on Windows startup.

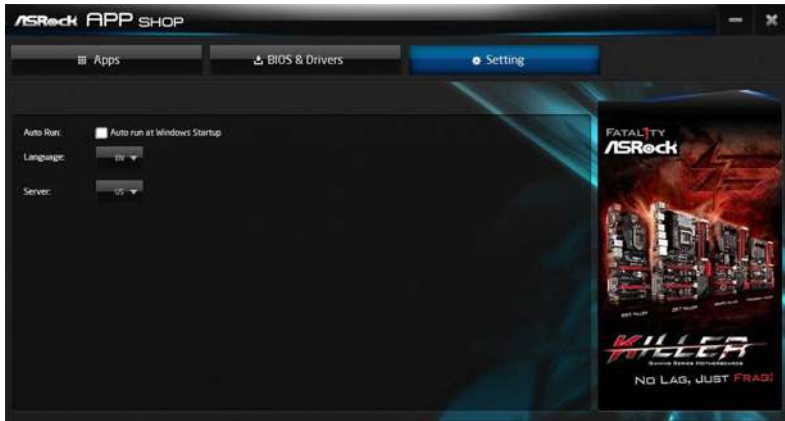

3.4 Enabling USB Ports for Windows® 7 Installation

Intel® new processors have removed their support for the Enhanced Host Controller Interface (EHCI – USB2.0) and only kept the eXtensible Host Controller Interface (XHCI – USB3.0). Due to that fact that XHCI is not included in the Windows 7 inbox drivers, users may find it difficult to install Windows 7 operating system because the USB ports on their motherboard won't work. In order for the USB ports to function properly, please create a Windows® 7 installation disk with the Intel® USB 3.0 eXtensible Host Controller (xHCI) drivers packed into the ISO file.

Requirements

- A Windows® 7 installation disk or USB drive
- A Windows® PC
- Win7 USB Patcher (included in the ASRock Support CD or downloaded from website)

Scenarios

You have an ODD and PS/2 ports:

If there is an optical disc drive, PS/2 ports and PS/2 Keyboard or mouse on your computer, you can skip the instructions below and go ahead to install Windows® 7 OS.

You've got nothing:

If you do not have an optical disc drive, please find another computer and follow the instructions below to create a new ISO file with the “Win7 USB Patcher”. Then use the new patched Windows® 7 installation USB drive to install Windows® 7 OS.

Instructions

Step 1

Insert the Windows® 7 installation disk or USB drive to your system.

Step 2

Extract the tool (Win7 USB Patcher) and launch it.

Step 3

Select how you want to install Windows 7 later.



Step 4

Locate your Win7 source folder or your ISO file.



Step 5

Select the USB storage, compact disk or destination folder for the new Windows 7 installation file.

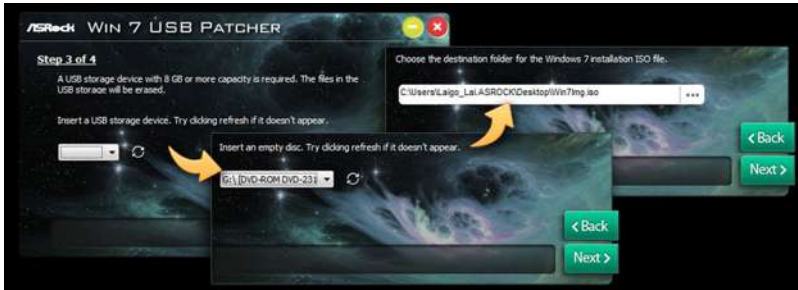

Step 6

Click "Start" to begin.



Step 7

Now you are able to install Windows® 7 on Intel® new processors with the new burned CD. Or please use the patched ISO image to make an OS USB drive to install the OS.

3.5 ASRock AURA RGB LED

ASRock AURA RGB LED allows you to build your own colorful lighting system. By connecting LED strip, you can adjust the RGB LED color through ASRock AURA RGB LED utility.

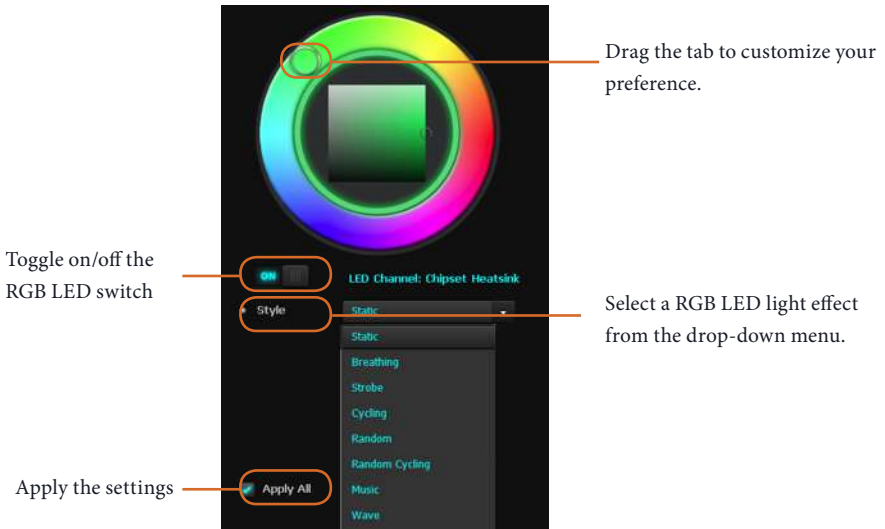

Chapter 4 UEFI SETUP UTILITY

4.1 Introduction

This section explains how to use the UEFI SETUP UTILITY to configure your system. You may run the UEFI SETUP UTILITY by pressing <F2> or right after you power on the computer, otherwise, the Power-On-Self-Test (POST) will continue with its test routines. If you wish to enter the UEFI SETUP UTILITY after POST, restart the system by pressing <Ctl> + <Alt> + <Delete>, or by pressing the reset button on the system chassis. You may also restart by turning the system off and then back on.



Because the UEFI software is constantly being updated, the following UEFI setup screens and descriptions are for reference purpose only, and they may not exactly match what you see on your screen.

4.2 EZ Mode

The EZ Mode screen appears when you enter the BIOS setup program by default. EZ mode is a dashboard which contains multiple readings of the system's current status. You can check the most crucial information of your system, such as CPU speed, DRAM frequency, SATA information, fan speed, etc.

Press <F6> or click the "Advanced Mode" button at the upper right corner of the screen to switch to "Advanced Mode" for more options.

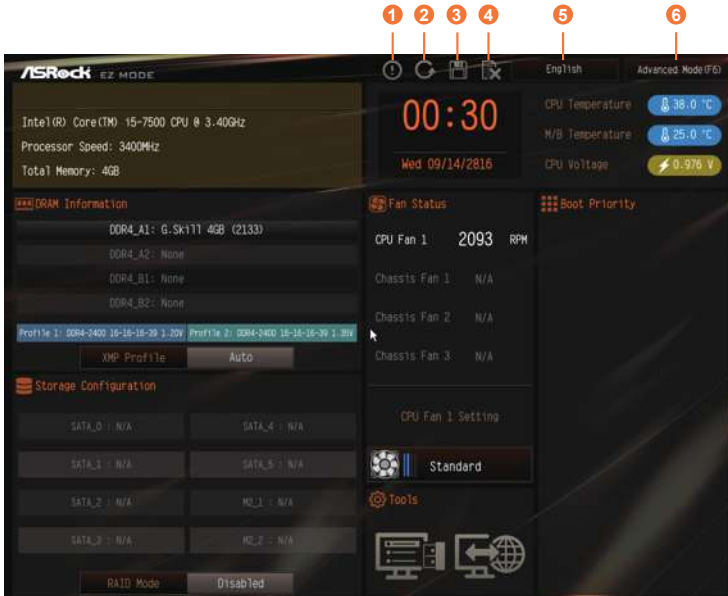

No.	Function
1	Help
2	Load UEFI Defaults
3	Save Changes and Exit
4	Discard Changes
5	Change Language
6	Switch to Advanced Mode

4.3 Advanced Mode

The Advanced Mode provides more options to configure the BIOS settings. Refer to the following sections for the detailed configurations.

To access the EZ Mode, press <F6> or click the "EZ Mode" button at the upper right corner of the screen.

4.3.1 UEFI Menu Bar

The top of the screen has a menu bar with the following selections:

Main	For setting system time/date information
OC Tweaker	For overclocking configurations
Advanced	For advanced system configurations
Tool	Useful tools
H/W Monitor	Displays current hardware status
Boot	For configuring boot settings and boot priority
Security	For security settings
Exit	Exit the current screen or the UEFI Setup Utility

4.3.2 Navigation Keys

Use <←> key or <→> key to choose among the selections on the menu bar, and use <↑> key or <↓> key to move the cursor up or down to select items, then press <Enter> to get into the sub screen. You can also use the mouse to click your required item.

Please check the following table for the descriptions of each navigation key.

Navigation Key(s)	Description
+ / -	To change option for the selected items
<Tab>	Switch to next function
<PGUP>	Go to the previous page
<PGDN>	Go to the next page
<HOME>	Go to the top of the screen
<END>	Go to the bottom of the screen
<F1>	To display the General Help Screen
<F5>	Add / Remove Favorite
<F7>	Discard changes and exit the SETUP UTILITY
<F9>	Load optimal default values for all the settings
<F10>	Save changes and exit the SETUP UTILITY
<F12>	Print screen
<ESC>	Jump to the Exit Screen or exit the current screen

4.4 Main Screen

When you enter the UEFI SETUP UTILITY, the Main screen will appear and display the system overview.



Favorite

Display your collection of BIOS items. Press F5 to add/remove your favorite items.

4.5 OC Tweaker Screen

In the OC Tweaker screen, you can set up overclocking features.



Because the UEFI software is constantly being updated, the following UEFI setup screens and descriptions are for reference purpose only, and they may not exactly match what you see on your screen.

Advanced Turbo

You can use this option to increase your system performance. This option appears only when your CPU supports this function. This option appears only when you adopt K-Series CPU.

Load Optimized CPU OC Setting

You can use this option to load optimized CPU overclocking setting. Please note that overclocking may cause damage to your CPU and motherboard. It should be done at your own risk and expense.

Load Optimized GPU OC Setting

You can use this option to load optimized GPU overclocking setting. Please note that overclocking may cause damage to your GPU and motherboard. It should be done at your own risk and expense. This option appears only when you adopt K-Series CPU.

CPU Configuration

Multi Core Enhancement

Improve the system's performance by forcing the CPU to perform the highest frequency on all CPU cores simultaneously. Disable to reduce power consumption .

CPU Ratio

The CPU speed is determined by the CPU Ratio multiplied with the BCLK. Increasing the CPU Ratio will increase the internal CPU clock speed without affecting the clock speed of other components.

CPU Cache Ratio

The CPU Internal Bus Speed Ratio. The maximum should be the same as the CPU Ratio.

Minimum CPU Cache Ratio

Set the minimum CPU Internal Bus Speed Ratio.

BCLK Frequency

The CPU speed is determined by the CPU Ratio multiplied with the BCLK. Increasing the BCLK will increase the internal CPU clock speed but also affect the clock speed of other components.

BCLK Spread Spectrum

Enable BCLK Spread Spectrum to reduce electromagnetic interference for passing EMI tests. Disable to achieve higher clock speeds when overclocking.

Boot Performance Mode

Select the performance state that the BIOS will set before OS handoff.

FCLK Frequency

Configure the FCLK Frequency.

AVX Ratio Offset

AVX Ratio Offset specifies a negative offset from the CPU Ratio for AVX workloads. AVX is a more stressful workload that lower the AVX ratio to ensure maximum possible ratio for SSE workloads.

Intel SpeedStep Technology

Intel SpeedStep technology allows processors to switch between multiple frequencies and voltage points for better power saving and heat dissipation.

Intel Turbo Boost Technology

Intel Turbo Boost Technology enables the processor to run above its base operating frequency when the operating system requests the highest performance state.

Intel Speed Shift Technology

Enable/Disable Intel Speed Shift Technology support. Enabling will expose the CPPC v2 interface to allow for hardware controlled P-states.

Long Duration Power Limit

Configure Package Power Limit 1 in watts. When the limit is exceeded, the CPU ratio will be lowered after a period of time. A lower limit can protect the CPU and save power, while a higher limit may improve performance.

Long Duration Maintained

Configure the period of time until the CPU ratio is lowered when the Long Duration Power Limit is exceeded.

Short Duration Power Limit

Configure Package Power Limit 2 in watts. When the limit is exceeded, the CPU ratio will be lowered immediately. A lower limit can protect the CPU and save power, while a higher limit may improve performance.

CPU Core Current Limit

Configure the current limit of the CPU core. A lower limit can protect the CPU and save power, while a higher limit may improve performance.

GT Slice Current Limit

Configure the current limit of the GT slice. A lower limit can protect the CPU and save power, while a higher limit may improve performance.

GT Frequency

Configure the frequency of the integrated GPU.

DRAM Configuration

DRAM Tweaker

Fine tune the DRAM settings by leaving marks in checkboxes. Click OK to confirm and apply your new settings.

DRAM Timing Configuration

Load XMP Setting

Load XMP settings to overclock the memory and perform beyond standard specifications.

BCLK Frequency

The CPU speed is determined by the CPU Ratio multiplied with the BCLK. Increasing the BCLK will increase the internal CPU clock speed but also affect the clock speed of other components.

DRAM Reference Clock

Select Auto for optimized settings.

DRAM Frequency

If [Auto] is selected, the motherboard will detect the memory module(s) inserted and assign the appropriate frequency automatically.

Primary Timing

CAS# Latency (tCL)

The time between sending a column address to the memory and the beginning of the data in response.

RAS# to CAS# Delay and Row Precharge (tRCDtRP)

RAS# to CAS# Delay: The number of clock cycles required between the opening of a row of memory and accessing columns within it.

Row Precharge: The number of clock cycles required between the issuing of the precharge command and opening the next row.

RAS# Active Time (tRAS)

The number of clock cycles required between a bank active command and issuing the precharge command.

Command Rate (CR)

The delay between when a memory chip is selected and when the first active command can be issued.

Secondary Timing

Write Recovery Time (tWR)

The amount of delay that must elapse after the completion of a valid write operation, before an active bank can be precharged.

Refresh Cycle Time (tRFC)

The number of clocks from a Refresh command until the first Activate command to the same rank.

RAS to RAS Delay (tRRD_L)

The number of clocks between two rows activated in different banks of the same rank.

RAS to RAS Delay (tRRD_S)

The number of clocks between two rows activated in different banks of the same rank.

Write to Read Delay (tWTR_L)

The number of clocks between the last valid write operation and the next read command to the same internal bank.

Write to Read Delay (tWTR_S)

The number of clocks between the last valid write operation and the next read command to the same internal bank.

Read to Precharge (tRTP)

The number of clocks that are inserted between a read command to a row pre-charge command to the same rank.

Four Activate Window (tFAW)

The time window in which four activates are allowed the same rank.

CAS Write Latency (tCWL)

Configure CAS Write Latency.

Third Timing**tREFI**

Configure refresh cycles at an average periodic interval.

tCKE

Configure the period of time the DDR4 initiates a minimum of one refresh command internally once it enters Self-Refresh mode.

tRDRD_sg

Configure between module read to read delay.

tRDRD_dg

Configure between module read to read delay.

tRDRD_dr

Configure between module read to read delay.

tRDRD_dd

Configure between module read to read delay.

tRDWR_sg

Configure between module read to write delay.

tRDWR_dg

Configure between module read to write delay.

tRDWR_dr

Configure between module read to write delay.

tRDWR_dd

Configure between module read to write delay.

tWRRD_sg

Configure between module write to read delay.

tWRRD_dg

Configure between module write to read delay.

tWRRD_dr

Configure between module write to read delay.

tWRRD_dd

Configure between module write to read delay.

tWRWR_sg

Configure between module write to write delay.

tWRWR_dg

Configure between module write to write delay.

tWRWR_dr

Configure between module write to write delay.

tWRWR_dd

Configure between module write to write delay.

Advanced Setting

MRC Fast Boot

Enable Memory Fast Boot to skip DRAM memory training for booting faster.

Voltage Configuration

CPU Vcore Voltage

Configure the voltage for the CPU Vcore.

CPU Load-Line Calibration

CPU Load-Line Calibration helps prevent CPU voltage droop when the system is under heavy loading.

GT Voltage

Configure the voltage for the integrated GPU.

GT Load-Line Calibration

GT Load-Line Calibration helps prevent integrated GPU voltage droop when the system is under heavy load.

DRAM Voltage

Use this to configure DRAM Voltage. The default value is [Auto].

DRAM Activating Power Supply

Configure the voltage for the DRAM Activating Power Supply.

PCH +1.0 Voltage

Configure the chipset voltage (1.0V).

VCCIO Voltage

Configure the voltage for the VCCIO.

VCCST Voltage

Configure the voltage for the VCCST.

VCCSA Voltage

Configure the voltage for the VCCSA.

Save User Default

Type a profile name and press enter to save your settings as user default.

Load User Default

Load previously saved user defaults.

Save User UEFI Setup Profile to Disk

It helps you to save current UEFI settings as an user profile to disk

Load User UEFI Setup Profile from Disk

You can load previous saved profile from the disk

4.6 Advanced Screen

In this section, you may set the configurations for the following items: CPU Configuration, Chipset Configuration, Storage Configuration, Intel® Thunderbolt, Super IO Configuration, ACPI Configuration, USB Configuration and Trusted Computing.



Setting wrong values in this section may cause the system to malfunction.

UEFI Configuration

UEFI Setup Style

Select the default mode when entering the UEFI setup utility.

Active Page on Entry

Select the default page when entering the UEFI setup utility.

Full HD UEFI

When [Auto] is selected, the resolution will be set to 1920 x 1080 if the monitor supports Full HD resolution. If the monitor does not support Full HD resolution, then the resolution will be set to 1024 x 768. When [Disable] is selected, the resolution will be set to 1024 x 768 directly.

4.6.1 CPU Configuration



Intel Hyper Threading Technology

Intel Hyper Threading Technology allows multiple threads to run on each core, so that the overall performance on threaded software is improved.

Active Processor Cores

Select the number of cores to enable in each processor package.

CPU C States Support

Enable CPU C States Support for power saving. It is recommended to keep C3, C6 and C7 all enabled for better power saving.

Enhanced Halt State (C1E)

Enable Enhanced Halt State (C1E) for lower power consumption.

CPU C3 State Support

Enable C3 sleep state for lower power consumption.

CPU C6 State Support

Enable C6 deep sleep state for lower power consumption.

CPU C7 State Support

Enable C7 deep sleep state for lower power consumption.

Package C State Support

Enable CPU, PCIe, Memory, Graphics C State Support for power saving.

CFG Lock

This item allows you to disable or enable the CFG Lock.

CPU Thermal Throttling

Enable CPU internal thermal control mechanisms to keep the CPU from overheating.

Intel Virtualization Technology

Intel Virtualization Technology allows a platform to run multiple operating systems and applications in independent partitions, so that one computer system can function as multiple virtual systems.

Hardware Prefetcher

Automatically prefetch data and code for the processor. Enable for better performance.

Adjacent Cache Line Prefetch

Automatically prefetch the subsequent cache line while retrieving the currently requested cache line. Enable for better performance.

SW Guard Extensions (SGX)

Intel SGX is a set of new CPU instructions that can be used by applications to set aside private regions of code and data.

4.6.2 Chipset Configuration



Primary Graphics Adapter

Select a primary VGA.

Top Of Lower Usable Dram

Maximum Value of TOLUD. Dynamic assignment would adjust TOLUD automatically based on largest MMIO length of installed graphic controller.

VT-d

Intel® Virtualization Technology for Directed I/O helps your virtual machine monitor better utilize hardware by improving application compatibility and reliability, and providing additional levels of manageability, security, isolation, and I/O performance.

PCIe1 Link Speed

Select the link speed for PCIe1.

PCIe2 Link Speed

Select the link speed for PCIe2.

PCIe3 Link Speed

Select the link speed for PCIe3.

PCIe4 Link Speed

Select the link speed for PCIe4.

PCIe5 Link Speed

Select the link speed for PCIe5.

PCIe6 Link Speed

Select the link speed for PCIe6.

PCI Express Native Control

Select Enable for enhanced PCI Express power saving in OS.

PCIe ASPM Support

This option enables/disables the ASPM support for all CPU downstream devices.

PCH PCIe ASPM Support

This option enables/disables the ASPM support for all PCH PCIe devices.

DMI ASPM Support

This option enables/disables the control of ASPM on CPU side of the DMI Link.

PCH DMI ASPM Support

This option enables/disables the ASPM support for all PCH DMI devices.

IOAPIC 24-119 Entries

I/O APICs contain a redirection table, which is used to route the interrupts it receives from peripheral buses to one or more local APICs. Enable/disable IOAPIC 24-119 Entries to expand to PIROI-PIROX.

Share Memory

Configure the size of memory that is allocated to the integrated graphics processor when the system boots up.

IGPU Multi-Monitor

Select disable to disable the integrated graphics when an external graphics card is installed. Select enable to keep the integrated graphics enabled at all times.

Onboard LAN

Enable or disable the onboard network interface controller.

Onboard HD Audio

Enable/disable onboard HD audio. Set to Auto to enable onboard HD audio and automatically disable it when a sound card is installed.

Front Panel

Enable/disable front panel HD audio.

Onboard HDMI HD Audio

Enable audio for the onboard digital outputs.

WAN Radio

Enable/disable the WiFi module's connectivity.

Deep Sleep

Configure deep sleep mode for power saving when the computer is shut down.

Restore on AC/Power Loss

Select the power state after a power failure. If [Power Off] is selected, the power will remain off when the power recovers. If [Power On] is selected, the system will start to boot up when the power recovers.

4.6.3 Storage Configuration



SATA Controller(s)

Enable/disable the SATA controllers.

SATA Controller Speed

Indicates the maximum speed the SATA controller can support.

SATA Mode Selection

AHCI: Supports new features that improve performance.

RAID: Combine multiple disk drives into a logical unit.

SATA Aggressive Link Power Management

SATA Aggressive Link Power Management allows SATA devices to enter a low power state during periods of inactivity to save power. It is only supported by AHCI mode.

Hard Disk S.M.A.R.T.

S.M.A.R.T stands for Self-Monitoring, Analysis, and Reporting Technology. It is a monitoring system for computer hard disk drives to detect and report on various indicators of reliability.

4.6.4 Intel® Thunderbolt™



Intel(R) Thunderbolt Technology

Enable/Disable the Intel(R) Thunderbolt function.

Security Level

Allows you to choose a security level for the Thunderbolt ports.

4.6.5 Super IO Configuration



Serial Port

Enable or disable the Serial port.

Serial Port Address

Select the address of the Serial port.

PS2 Y-Cable

Enable the PS2 Y-Cable or set this option to Auto.

4.6.6 ACPI Configuration



Suspend to RAM

Select disable for ACPI suspend type S1. It is recommended to select auto for ACPI S3 power saving.

ACPI HEPT Table

Enable the High Precision Event Timer for better performance.

PS/2 Keyboard Power On

Allow the system to be waked up by a PS/2 Keyboard.

PCIE Devices Power On

Allow the system to be waked up by a PCIE device and enable wake on LAN.

Ring-In Power On

Allow the system to be waked up by onboard COM port modem Ring-In signals.

RTC Alarm Power On

Allow the system to be waked up by the real time clock alarm. Set it to By OS to let it be handled by your operating system.

USB Keyboard/Remote Power On

Allow the system to be waked up by an USB keyboard or remote controller.

USB Mouse Power On

Allow the system to be waked up by an USB mouse.

4.6.7 USB Configuration



Legacy USB Support

Enable or disable Legacy OS Support for USB 2.0 devices. If you encounter USB compatibility issues it is recommended to disable legacy USB support. Select UEFI Setup Only to support USB devices under the UEFI setup and Windows/Linux operating systems only.

PS/2 Simulator

Enable PS/2 Simulator. This should be enabled for the complete USB keyboard legacy support for non-USB aware OSes.

*Enable this option if you install Windows 7.

XHCI Hand-off

This is a workaround for OSes without XHCI hand-off support. The XHCI ownership change should be claimed by XHCI driver.

4.6.8 Trusted Computing



Security Device Support

Enable or disable BIOS support for security device.

4.7 Tools



System Browser

ASRock System Browser shows the overview of your current PC and the devices connected.

UEFI Tech Service

Contact ASRock Tech Service if you are having trouble with your PC. Please setup network configuration before using UEFI Tech Service.

Easy RAID Installer

Easy RAID Installer helps you to copy the RAID driver from the support CD to your USB storage device. After copying the drivers please change the SATA mode to RAID, then you can start installing the operating system in RAID mode.

Easy Driver Installer

For users that don't have an optical disk drive to install the drivers from our support CD, Easy Driver Installer is a handy tool in the UEFI that installs the LAN driver to your system via an USB storage device, then downloads and installs the other required drivers automatically.

Boot Manager

Boot Manager is specifically designed for the dual OS platform/multi-OS platform users to easily customize and manage the boot menu.

*Please connect more than one boot devices to use this tool.



Boot Manager

Enable/disable the Boot Manager.

Boot Manager Timeout

Enable/disable the Boot Manager Timeout.

Timeout Seconds

Configure the number of seconds to wait for the Boot Manager.

Instant Flash

Save UEFI files in your USB storage device and run Instant Flash to update your UEFI.

Internet Flash - DHCP (Auto IP), Auto

ASRock Internet Flash downloads and updates the latest UEFI firmware version from our servers for you. Please setup network configuration before using Internet Flash.

*For BIOS backup and recovery purpose, it is recommended to plug in your USB pen drive before using this function.

Network Configuration

Use this to configure internet connection settings for Internet Flash.

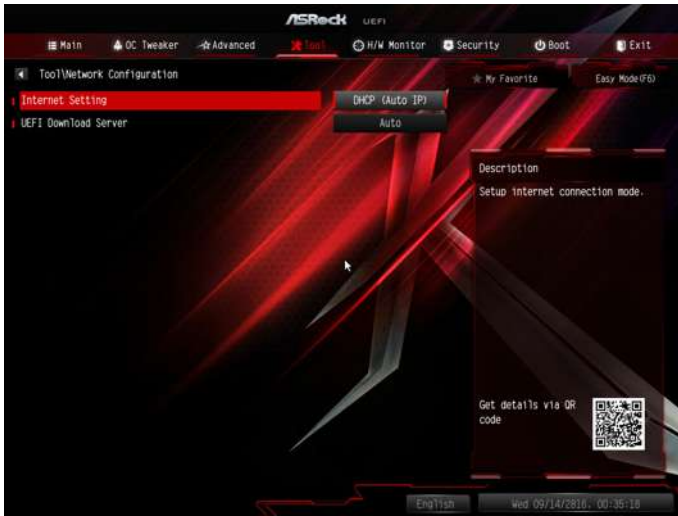

Internet Setting

Enable or disable sound effects in the setup utility.

UEFI Download Server

Select a server to download the UEFI firmware.

4.8 Hardware Health Event Monitoring Screen

This section allows you to monitor the status of the hardware on your system, including the parameters of the CPU temperature, motherboard temperature, fan speed and voltage.



Fan Tuning

Measure Fan Min Duty Cycle.

Fan-Tastic Tuning

Select a fan mode for CPU Fans 1&2, or choose Customize to set 5 CPU temperatures and assign a respective fan speed for each temperature.

CPU Fan 1 Setting

Select a fan mode for CPU Fans 1, or choose Customize to set 5 CPU temperatures and assign a respective fan speed for each temperature.

CPU Fan Step Up

Set the value of CPU Fan Step Up.

CPU Fan Step Down

Set the value of CPU Fan Step Down.

Chassis Fan 1 Setting

Select a fan mode for Chassis Fan 1, or choose Customize to set 5 CPU temperatures and assign a respective fan speed for each temperature.

Chassis Fan 1 Temp Source

Select a fan temperature source for Chassis Fan 1.

Chassis Fan 1 Step Up

Set the value of Chassis Fan 1 Step Up.

Chassis Fan 1 Step Down

Set the value of Chassis Fan 1 Step Down.

Chassis Fan 2 Setting

Select a fan mode for Chassis Fan 2, or choose Customize to set 5 CPU temperatures and assign a respective fan speed for each temperature.

Chassis Fan 2 Temp Source

Select a fan temperature source for Chassis Fan 2.

Chassis Fan 2 Step Up

Set the value of Chassis Fan 2 Step Up.

Chassis Fan 2 Step Down

Set the value of Chassis Fan 2 Step Down.

CHA_FAN3 / W_Pump Switch

Select CHA_FAN3/CPU Optional or Water Pump mode.

Chassis Fan 3 Control Mode

Select PWM mode or DC mode for Chassis Fan 3.

Chassis Fan 3 Setting

Select a fan mode for Chassis Fan 3, or choose Customize to set 5 CPU temperatures and assign a respective fan speed for each temperature.

Chassis Fan 3 Temp Source

Select a fan temperature source for Chassis Fan 3.

Chassis Fan 3 Step Up

Set the value of Chassis Fan 3 Step Up.

Chassis Fan 3 Step Down

Set the value of Chassis Fan 3 Step Down.

Over Temperature Protection

When Over Temperature Protection is enabled, the system automatically shuts down when the motherboard is overheated.

Case Open Feature

Enable or disable Case Open Feature to detect whether the chassis cover has been removed.

4.9 Security Screen

In this section you may set or change the supervisor/user password for the system. You may also clear the user password.



Supervisor Password

Set or change the password for the administrator account. Only the administrator has authority to change the settings in the UEFI Setup Utility. Leave it blank and press enter to remove the password.

User Password

Set or change the password for the user account. Users are unable to change the settings in the UEFI Setup Utility. Leave it blank and press enter to remove the password.

Secure Boot

Use this item to enable or disable support for Windows 8.1 Secure Boot.

Intel(R) Platform Trust Technology

Enable/disable Intel PTT in ME. Disable this option to use discrete TPM Module.

4.10 Boot Screen

This section displays the available devices on your system for you to configure the boot settings and the boot priority.



Boot From Onboard LAN

Allow the system to be waked up by the onboard LAN.

Setup Prompt Timeout

Configure the number of seconds to wait for the setup hot key.

Bootup Num-Lock

Select whether Num Lock should be turned on or off when the system boots up.

Boot Beep

Select whether the Boot Beep should be turned on or off when the system boots up. Please note that a buzzer is needed.

Full Screen Logo

Enable to display the boot logo or disable to show normal POST messages.

AddOn ROM Display

Enable AddOn ROM Display to see the AddOn ROM messages or configure the AddOn ROM if you've enabled Full Screen Logo. Disable for faster boot speed.

Boot Failure Guard Message

If the computer fails to boot for a number of times the system automatically restores the default settings.

CSM (Compatibility Support Module)



CSM

Enable to launch the Compatibility Support Module. Please do not disable unless you're running a WHCK test. If you are using Windows 8.1 64-bit and all of your devices support UEFI, you may also disable CSM for faster boot speed.

Launch PXE OpROM Policy

Select UEFI only to run those that support UEFI option ROM only. Select Legacy only to run those that support legacy option ROM only. Select Do not launch to not execute both legacy and UEFI option ROM.

Launch Storage OpROM Policy

Select UEFI only to run those that support UEFI option ROM only. Select Legacy only to run those that support legacy option ROM only. Select Do not launch to not execute both legacy and UEFI option ROM.

Launch Video OpROM Policy

Select UEFI only to run those that support UEFI option ROM only. Select Legacy only to run those that support legacy option ROM only. Select Do not launch to not execute both legacy and UEFI option ROM.

4.11 Exit Screen



Save Changes and Exit

When you select this option the following message, “Save configuration changes and exit setup?” will pop out. Select [OK] to save changes and exit the UEFI SETUP UTILITY.

Discard Changes and Exit

When you select this option the following message, “Discard changes and exit setup?” will pop out. Select [OK] to exit the UEFI SETUP UTILITY without saving any changes.

Discard Changes

When you select this option the following message, “Discard changes?” will pop out. Select [OK] to discard all changes.

Load UEFI Defaults

Load UEFI default values for all options. The F9 key can be used for this operation.

Launch EFI Shell from filesystem device

Copy shellx64.efi to the root directory to launch EFI Shell.

Contact Information

If you need to contact ASRock or want to know more about ASRock, you're welcome to visit ASRock's website at <http://www.asrock.com>; or you may contact your dealer for further information. For technical questions, please submit a support request form at <http://www.asrock.com/support/tsd.asp>

ASRock Incorporation

2F., No.37, Sec. 2, Jhongyang S. Rd., Beitou District,

Taipei City 112, Taiwan (R.O.C.)

ASRock EUROPE B.V.

Bijsterhuizen 11-11

6546 AR Nijmegen

The Netherlands

Phone: +31-24-345-44-33

Fax: +31-24-345-44-38

ASRock America, Inc.

13848 Magnolia Ave, Chino, CA91710

U.S.A.

Phone: +1-909-590-8308

Fax: +1-909-590-1026